

Installation And Care Instructions

Honeycomb Cordlock Shades

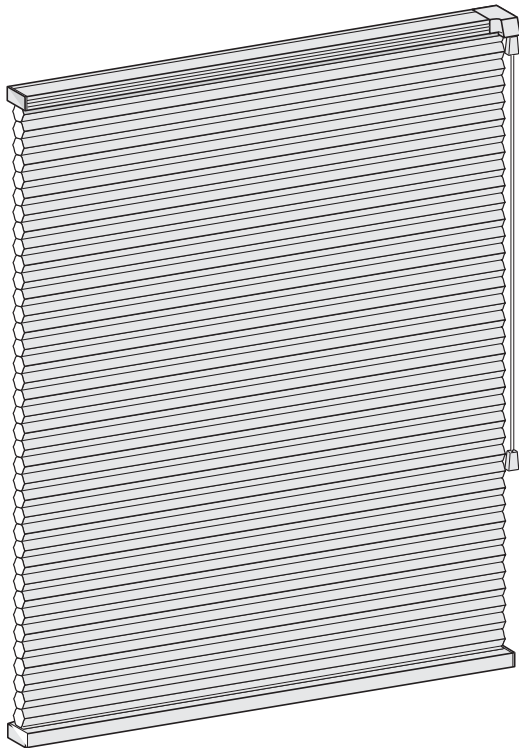

Standard Rectangular Shades

HunterDouglas

THANK YOU for purchasing a Hunter Douglas product. Your new window shade has been custom built for you from the highest quality materials. Once in your window, it will provide you with a lifetime of beauty and trouble-free use.

Getting Started

- Remove the shade from the package. Keep the packaging until the shade operates to your satisfaction.
- Check the diagram to make sure you have the necessary parts.

NOTE: Non-operable sidelight shades, less than 12" wide, do not have lift cords.

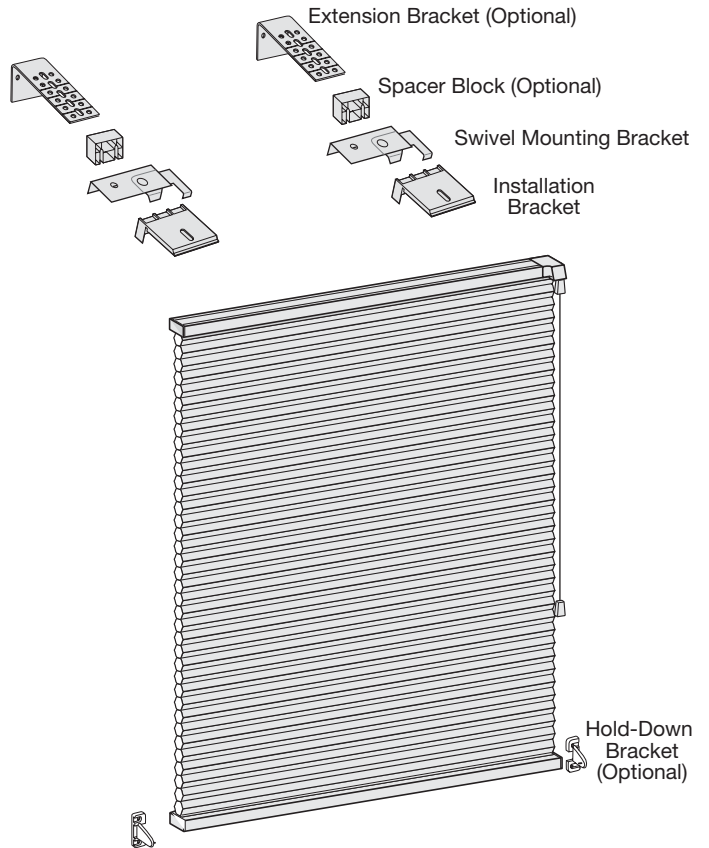

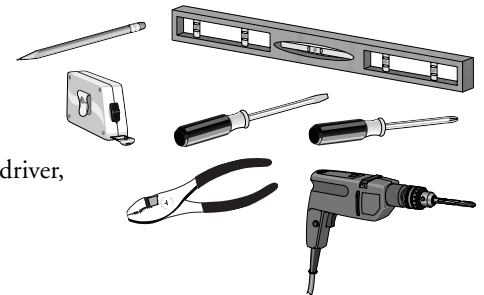

Tools needed for installing your shade:

- Flat blade and Phillips screwdriver
- Level
- Measuring tape
- Pencil
- Pliers
- Power drill, 1/4" hex driver, and drill bits



For assistance, call the Hunter Douglas
Customer Information Center
at 1-888-501-8364
Visit our Web site at hunterdouglas.com

In addition, you will need fasteners designed to work with your specific mounting surfaces:

Mounting Surface	Fastener
Wood	No. 6 Hex Head Screws (Provided) 
Drywall, Plaster	Wall Anchors, Expansion Bolts (Not Provided) 
Metal	Sheet Metal Screws (Not Provided) 

Contents of the hardware package may vary depending upon how the shade was ordered and whether the shade will be inside or outside mounted.

1 Mount The Installation Brackets

Bracket Requirements

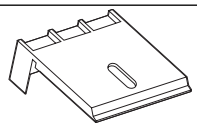
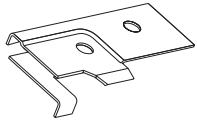
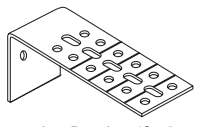
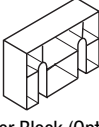
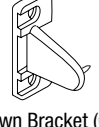
Bracket Type	Brackets Required For Headrail Width				
	Up to 31"	31 1/8" to 79"	79 1/8" to 96"	96 1/8" to 139"	139 1/8" to 174"
 3/8" & 3/4"* Installation Bracket	2	3	4	5	6
 3/8" & 3/4"* Swivel Installation Bracket (Optional)	2	3	4	5	6
 Extension Bracket (Optional)	2	3	4	5	6
 Spacer Block (Optional)	1-3 per bracket				
 Hold-Down Bracket (Optional)	2				

*Double and triple honeycomb included

Bracket Placement

- Measure 3" in from the ends of the headrail and mark the bracket location on the mounting surface.
- Bracket placement is the same for inside and outside mounts.

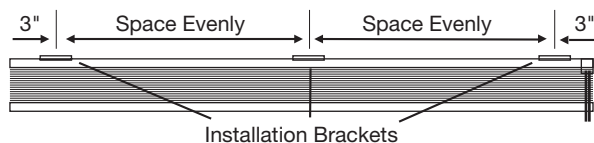

Inside Mount Applications

The depth required for a fully recessed mount depends upon the application.

Depth Chart For Bracket Placement

Bracket Type	Minimum	Fully Recessed
3/8"	1"	1 1/2"
3/4"*	1"	2 1/4"
3/8" Swivel	1/2"	1 1/8"
3/4" Swivel*	1/2"	2"

*Double and triple honeycomb included

NOTE: Add to the minimum depth the dimension of obstructions such as window cranks or handles.

Use one mounting screw to attach each installation bracket to the top sill of the window opening.

The 3/4" swivel installation bracket has two holes in the bracket:

- Use the front hole if a 1" mounting depth is available.
- Use the rear hole if the mounting depth is between 1/2" and 1".

Installation Bracket

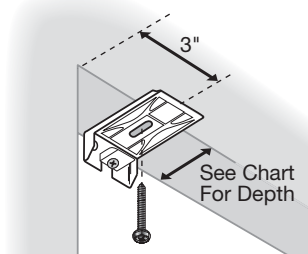

Swivel Bracket

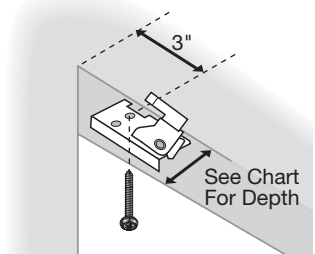

Outside Mount Applications

Use a level to align the brackets. Use two screws for each bracket. Minimum height requirements:

- 5/8" for 3/8" brackets
- 1" for 3/4" brackets

Installation Bracket For 3/8" Pleat Size

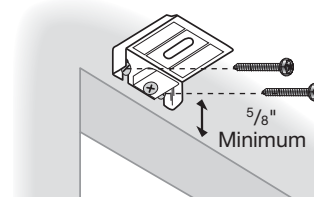

Installation Bracket For 3/4" Pleat Size, Double And Triple Honeycomb

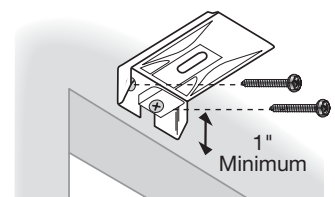

Spacer Blocks (Optional)

Each spacer block projects brackets 1/2" away from the mounting surface.

- Mount spacer blocks with the solid side facing the mounting surface.
- Use two mounting screws. Screws should be long enough to secure the bracket to the mounting surface.
- Use a maximum of three spacer blocks per bracket.

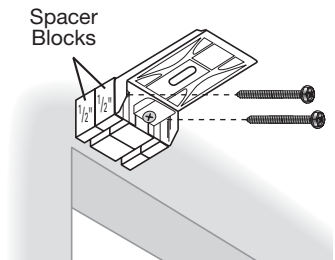

Extension Brackets (Optional)

Extension brackets project installation brackets up to 2 1/2" away from the mounting surface. Allow additional clearance for obstructions such as window cranks or handles.

- Use pliers or, if necessary, a metal saw to shorten extension brackets at indentations.
- Align and level brackets with a level.
- Attach installation brackets to the underside of extension brackets using the provided screws and nuts.

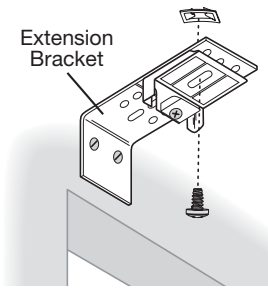

NOTE: Use the same screw holes on each extension bracket to ensure brackets are projected an equal distance from the mounting surface.

End Mount Applications

For specific installation instructions, see the *Honeycomb Shades End Mount Installation Instructions*.

2 Install The Shade

Installation Brackets

- Position the shade so the colored side of the fabric faces you.
- Insert the headrail at an angle and rotate upward to snap into place.
- Tighten the tab screw on each bracket until snug. Do not overtighten.

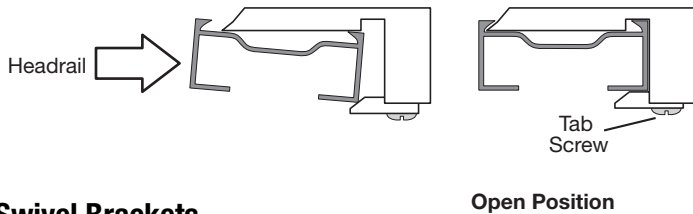

Swivel Brackets

- Place the swivel brackets in the open position as illustrated.
- Place the headrail against the back of the installation brackets.
- Rotate the swivel arm to snap the locking tab under the headrail.
- The shade is locked when the push tab is against the headrail.

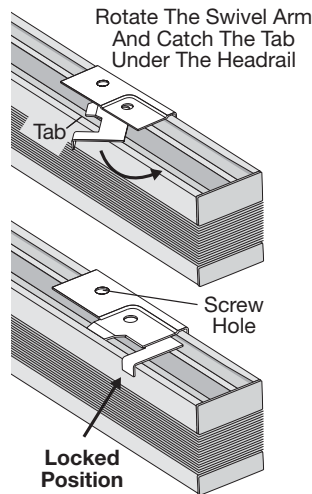

Bottom Rails (Sidelight Shades Only)

- After installing the headrail, slide the bottom rail into the brackets at an angle.
- Rotate the rail to snap it into place.
- Tighten the tab screws until snug. Do not overtighten.

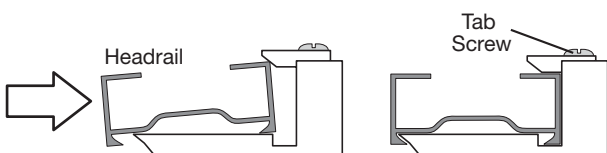

3 Operate The Shade

- Keep the cord close to the fabric when operating the shade.
- To raise or lower the shade, disengage the cordlock by moving the cord toward the center of the shade.
- Pull on the cord to raise the shade.
- Engage the cordlock by returning the cord to the original position.

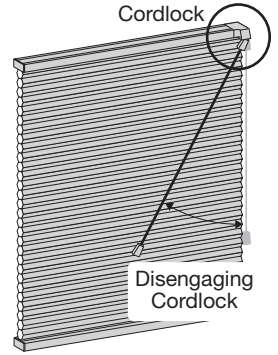

4 Adjust The Shade

Verify Shade Length

- Raise and lower the shade several times.
- If the length needs to be adjusted or the bottom rail is not level, use the following steps to correct.

Shade Length Adjustment

Shade height and adjustments to level the bottom rail can be made by adjusting the cord on the underside of the bottom rail.

- Locate the ferrule, which is seated in a pocket on the bottom rail.
- Remove the ferrule by pulling on the excess cord.
- Unthread one loop of the cord by pulling it through the ferrule.
- Slide the ferrule along the cord to adjust the length of the shade and to level the bottom rail.
- Lock the ferrule in place by looping the cord through the top of the ferrule. Make sure the loop fits in the groove on the side of the ferrule.
- Slide the ferrule fully back into the pocket.
- Once you are certain of the final adjustments, trim the cord flush with the ferrule and bottom rail.

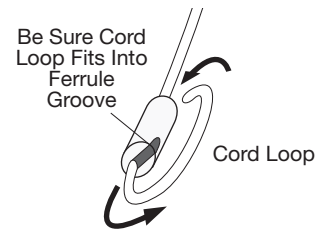
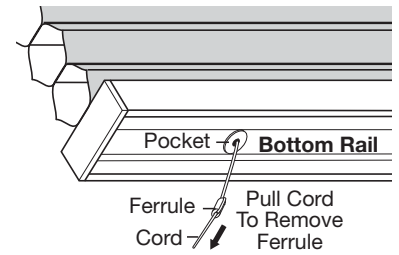

Tassel Cord Length

The tassel cord length is usually $\frac{2}{3}$ the length of the fully closed shade. To shorten the tassel cord, slide the tassel up the cord to the desired location and knot the cord. Trim the excess cord below the knot.

Attach Hold-Down Brackets (Optional)

Hold-down brackets can only be used on outside mounted shades.

- Lower the shade and place the pins from the hold-down brackets into the bottom rail end caps.
- On the mounting surface, mark the bracket hole locations.
- Check that the brackets are level and attach them to the mounting surface using two screws.

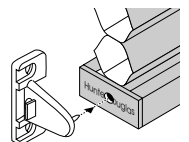

5 Remove The Shade

- Fully raise the shade.
- Unscrew the tab screw on each bracket to release the headrail.

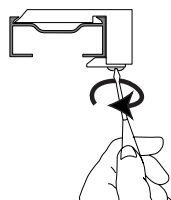

6 Care And Cleaning

Hunter Douglas honeycomb shades are made of an anti-static, dust-resistant fabric which repels dirt and dust. For most honeycomb fabrics, the following options are available if your shade needs cleaning.

Dusting

Regular light dusting with a feather duster is all the cleaning that is needed in most circumstances.

Vacuuming

Use a hand-held vacuum with low suction for more thorough dust removal.



Spot-Cleaning

- Prepare a solution of warm water and a mild detergent.
- Dampen a clean cloth in the solution and wring it out.
- Dab the spot with the dampened cloth until it is gone. **Do not rub the fabric.**
- Allow the shade to dry in the completely lowered position.

CAUTION: Do not spot-clean Purescence™ fabrics.

Deep Cleaning

- Immerse the shade in a basin or bathtub filled with a mild detergent.
- Rinse with clean water.
- Fully raise the shade and tilt to eliminate excess water.
- Reinstall the damp shade, lower it, and let it dry completely.

CAUTION: Do not immerse any Purescence or opaque fabrics.

Ultrasonic Cleaning

Some honeycomb fabrics can be ultrasonically cleaned by a professional.

- Specify that a mild detergent solution be used.
- Never immerse the headrail in the solution.
- Dry the shade completely in the lowered position.

CAUTION: Do not ultrasonically clean any Casuelle™, Purescence, or opaque fabrics.

Injection/Extraction

Honeycomb shades can be professionally cleaned using the injection/extraction method.

- A dry method of injection/extraction is required for Casuelle and opaque fabrics.

CAUTION: Do not use injection/extraction cleaning on Purescence fabrics.

For more comprehensive cleaning instructions, call the Hunter Douglas Customer Information Center toll free at:

1-888-501-8364

7 Child Safety

WARNING

For more safety information call 1-888-501-8364 in the U.S. or 1-866-662-0666 in Canada.

Young children can STRANGLE in cord and bead chain loops and in the loop above the cord stop. They can also wrap cords around their necks and STRANGLE.

- Always keep cords and bead chains out of children's reach.
- Move cribs, playpens and other furniture away from cords and bead chains. Children can climb furniture to get to cords.

Hunter Douglas provides cord cleats and we recommend their use.

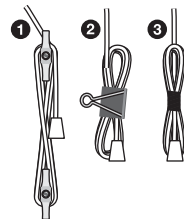

1. **Cord Cleats.** Attach two cord cleats 6" to 12" apart at a height where they will be out of the reach of children. Take into account that a child may stand on furniture attempting to reach the cords. Be sure the cleats are firmly secured. Once the cleats are attached, wrap excess cord around them after each use of the shade.

2. **Cord Clip.** Clip the cord to itself using a clamping device.

3. **Tie.** Wrap or tie the cord to itself.

8 Troubleshooting

Problem	Solution
The shade does not raise and lower evenly.	<ul style="list-style-type: none"> • Check the installation brackets. Make sure the shade fabric is not caught between the bracket tab and the headrail. • Check that the lift cords are not pinched or tangled.
The shade will not snap into the mounting brackets.	<ul style="list-style-type: none"> • Make sure the mounting brackets are level. Loosen the tab screws slightly.
The shade will not raise.	<ul style="list-style-type: none"> • If hold-down brackets are used, make sure they have been released.
The lift cords hang from the bottom rail.	<ul style="list-style-type: none"> • The cords provide an easy way to level the bottom rail. Once adjusted correctly, cut off the extra cord.



HunterDouglas

LIGHT CAN CHANGE EVERYTHING™

hunterdouglas.com

© 1985, 2006 Hunter Douglas Inc. © Registered trademark of Hunter Douglas Inc.
™Trademark of Hunter Douglas Inc. Patented in the U.S. and foreign countries.
Other U.S. and foreign patents pending.



PCN 5109145000

Rev. 9/06